

# SHELL SCHEME INFO



# INTRODUCING NAUTILUS EXHIBITIONS



Nautilus Exhibitions are the official stand contractors for UK Games Expo.

We can provide you with a variety of components for your stand space to help make you stand out from the crowd.

If you have any queries outside of the information within these pages, please contact:

**Jack Penn & Martin Neale**  
**info@nautilusexhibitions.co.uk**  
**01327 304058**

## ORDER DEADLINE

The deadline for UK Games Expo is **14th July 2021**.

After this date, a late order surcharge of 20% will be applied to your order.



**Nautilus**  
EXHIBITIONS



# SHELL SCHEME



You are provided with a space only stand at UK Games Expo. Adding shell scheme to your stand is an excellent and cost-effective way to provide delineation between you and the next exhibitor. It can also provide a perfect backdrop for product displays and graphic panels.

The picture shows an example of a corner stand with 2 walls and 2 open sides. A shell scheme stand option comprises:

- Aluminium framework
- White foamex panels
- Nameboard with company name and stand number (26 character limit)

There are many additions elements that you can add to your shell scheme:

- Storeroom with lockable door
- Ability to have a wall mounted screen
- Shelving
- Different types of lighting to illuminate key areas on the stand



# SHELL SCHEME DETAIL

## Basic shell scheme: components

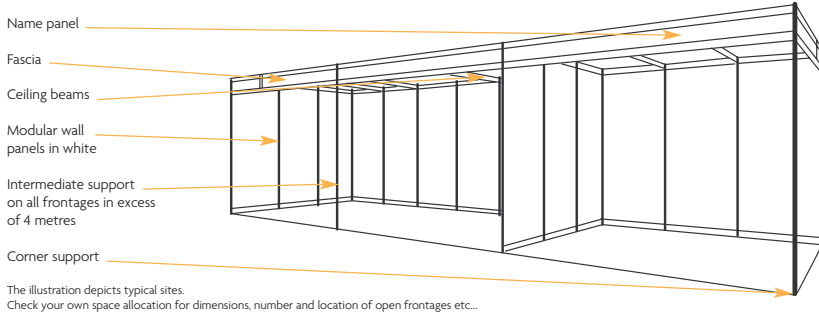

## Basic shell scheme: dimensions

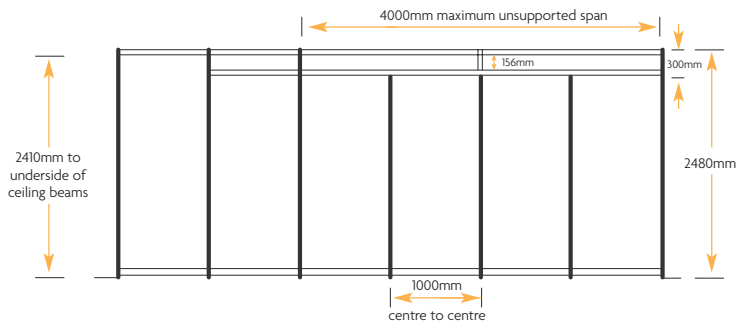

## Panels and sections: dimensions

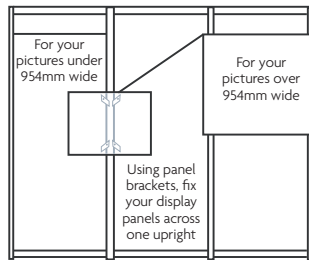
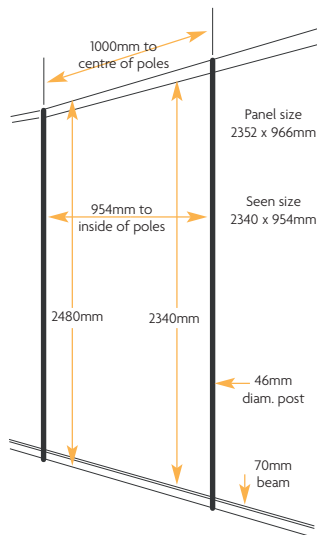

## Beam sections

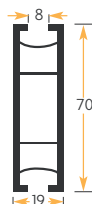

## Post sections

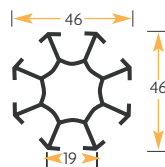

## DO'S & DONT'S

We hope you and your shell scheme in order. Please observe the do's & don'ts associated with this system.



The use of the following fixings is strictly forbidden on this system:

**NAILS / SCREWS / PINS / STAPLES / PAINTING.**

Fixing is permitted by:

**Melamine / Vinyl Panels**

- BLU-TAC
- VELCRO HOOK & LOOP
- PANEL BRACKETS
- HANGING CHAINS FOR HEAVY EXHIBITS



# FLOOR COVERINGS



Nautilus Exhibitions can provide a range of floorcovering services.

Above is the cord carpet colour chart which is the standard floorcovering provided at exhibitions.

**Cost: £20.00 per sqm (ex VAT)**

without protective polythene.

**Protected Polythene: £10.00 per sqm (ex VAT)**

Also available is velour carpet, vinyl floorcovering and other bespoke coverings such as AstroTurf, wooden plank flooring and linoleum etc.

If you would like to place an order, please complete the form at the end of this brochure.



# FURNITURE AND GRAPHICS



## FURNITURE

There are a wide range of furniture options available to hire for the event, including:

- Lockable cabinets
- Reception counters
- Poseur tables
- Stools
- Bistro tables
- Chairs
- Display plinths

Please go to the furniture section of the UK Games Expo website to view different options available and place your order.

## GRAPHICS

Perhaps the best way to make your space stand out is to add graphics to the shell scheme. We offer two types—inserted graphic panels and stretch fabric banners.

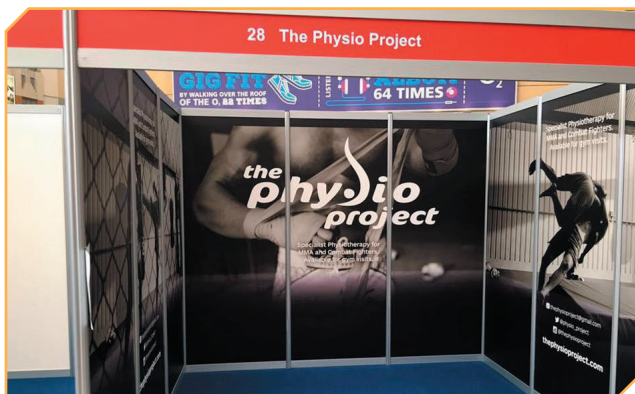

### Inserted Graphics

Printed panels that slot into the framework of the shell scheme instead of the standard white panels.

Panels can be taken away for reuse.

**Cost: £165 per metre width (ex VAT)**

#### Supplying artwork (Inserted graphics)

Please supply your artwork as high-resolution, print ready PDF files with 5mm bleed on all sides. See page 4 (Shell scheme detail) for sizes.



### Stretch Fabric Banners

Printed banners that are fitted to their own framework and then mounted on top of the shell scheme framework. Provide seamless image across one wall.

Banners can be taken away with you for reuse.

**Cost: £200 per metre width (ex VAT)**

#### Supplying artwork (Inserted graphics)

Please supply your artwork as high-resolution, print ready PDF files with 100mm bleed on all sides. See page 4 (Shell scheme detail) for sizes.

For more information on any of these options, please contact us at: [info@nautilusexhibitions.co.uk](mailto:info@nautilusexhibitions.co.uk)



# SCREEN HIRE



## Nautilus Exhibitions offer a range of screens to hire for the event.

The screens come equipped with the correct mounting brackets and required fixings for the shells scheme. When ordering your screen(s) please confirm the type of graphics you will be having on your stand as this will affect the type of bracket required.

Screens that support USB playback can play .JPG & .PNG image files & .MP4 video files on a loop.

All screens support a HDMI input.

If a different connection is required, we recommend that you contact us to discuss your requirements.

**40" – 43"**

**Screen hire cost: £290.00 (ex VAT)**

**32"**

**Screen hire cost: £230.00 (ex VAT)**

For more information on any of these options, please contact us at:

**[info@nautilusexhibitions.co.uk](mailto:info@nautilusexhibitions.co.uk)**



**Nautilus**  
EXHIBITIONS 

# BESPOKE DESIGN

Nautilus Exhibitions can take the pain of exhibiting out of your hands, offering a complete design and build service.

We can help with the initial design and concept of your stand, engaging with your brand and successfully understanding exactly what it is you want to achieve.

Our build team will ensure that the stand is constructed to highest standard meaning you just need to turn up on the day of the event and enjoy!



For more information on any of these options, please contact us at:  
[info@nautilusexhibitions.co.uk](mailto:info@nautilusexhibitions.co.uk)





# ORDER FORM - ADDITIONAL STAND FITTING

Venue: \_\_\_\_\_ Date: \_\_\_\_\_

**Deadline for return of form: Wednesday 14th July 2021**

Hall no. \_\_\_\_\_ Stand no. \_\_\_\_\_

Company: \_\_\_\_\_

Invoice Address: \_\_\_\_\_

\_\_\_\_\_

Postcode: \_\_\_\_\_

Telephone: \_\_\_\_\_ Email: \_\_\_\_\_

Contact: \_\_\_\_\_

Signature:

Date: \_\_\_\_\_

**Orders made after the deadline will be subject to a 20% surcharge.**

	Unit Price	No. Units	Total Cost (ex VAT)
<b>SHELL SCHEME</b>			
WALL PANEL 2.48m high x 1m wide. These are supplied and fitted to your specification.	£24.00		
WALL PANEL 2.48m high x 0.5m wide. These are supplied and fitted to your specification.	£13.80		
1M X 1M CORNER STOREROOM. 2.48m high x 1m wide x 1m deep solid walls. Contains 1 outward opening lockable door with paint finish	£334.00		
1M X 2M CORNER STOREROOM. 2.48m high x 1m wide x 2m deep solid walls. Contains 1 outward opening lockable door with paint finish.	£385.00		
<b>FASCIA</b>			
1.5m Fascia	£59.00		
2m Fascia	£78.00		
3m Fascia	£117.00		
4m Fascia	£156.00		
<b>CROSS RAIL</b>			
1.3m Cross Rail	£21.50		
1.5m Cross Rail	£23.50		
2m Cross Rail	£31.50		
3m Cross Rail	£47.00		



	Unit Price	No. Units	Total Cost (ex VAT)
<b>ACCESSORIES</b>			
CURTAINED ENTRANCE WAY: CURTAIN ON TRACK. Fits into a 1m panel.	£91.00		
HAT AND COAT RACK. 5 hooks on 1m batten.	£27.50		
FLAT SHELF. 1000mm x 300mm white melamine flat shelf	£45.50		
ANGLED SHELF. 1000mm x 300mm white melamine angled shelf	£47.50		
GARMENT RAIL. 25mm diameter - 1m long, installed 280mm from wall	£36.00		
CHAIN HANGING PACKS. 2 hooks and chains	£28.50		
VELCRO: SELF ADHESIVE. £16 per l/m. Includes hook and loop	£16.00		
SHELL SCHEME LOCKABLE COUNTER. 1m(h) x 1m(w) x 0.5m(d). Shell Scheme counter with sliding lockable doors. Graphic can be applied to the front at an additional cost.	£103.50		
SHELL SCHEME SCREEN SUPPORT. 1m wide screen support, attached to the shell scheme system. This will provide support for a screen bracket to be attached. Please note, brackets need to be ordered separately and will be an additional cost. Screen support is not compatible with uninterrupted graphic panels.	£80.00		
SHELL SCHEME SCREEN PAD. 1m wide pad that a screen attaches to. Bracket to be ordered separately and an additional cost. Screen pad is suitable for use with uninterrupted graphics.	£100.00		
<b>LIGHTING OPTIONS</b>			
120W General Purpose Spotlight	£63.00		
50W Low Voltage Spotlight	£81.00		
500W Sunflood Fitting	£117.00		
<b>GRAPHIC OPTIONS</b>			
INSERTED GRAPHICS. 2.48m high x 1m wide graphic panels. Price is per panel.	£165.00		
STRETCH FABRIC BANNERS. Printed and fitted to a frame that is mounted to the shell scheme. Price is per meter width.	£200.00		
<b>AUDIO VISUAL EQUIPMENT</b>			
40' - 43' Wall Mounted Screen Hire	£290.00		
32" Wall Mounted Screen Hire	£230.00		
<b>FLOORING</b>			
Cord Carpet (Per sqm)	£20.00		
Vinyl Floor Covering (Per sqm)	£32.00		
Protective Polythene Covering (Per sqm)	£10.00		
<b>BESPOKE DESIGN &amp; BUILD</b>			

Please contact the Nautilus Exhibition team to discuss your requirements and a specific quote will be sent through to you.

Sub-total	
20% late order surcharge	
VAT @ 20%	
Total	



# STAND FITTING PLAN

Show: \_\_\_\_\_

Venue: \_\_\_\_\_

Stand no.: \_\_\_\_\_





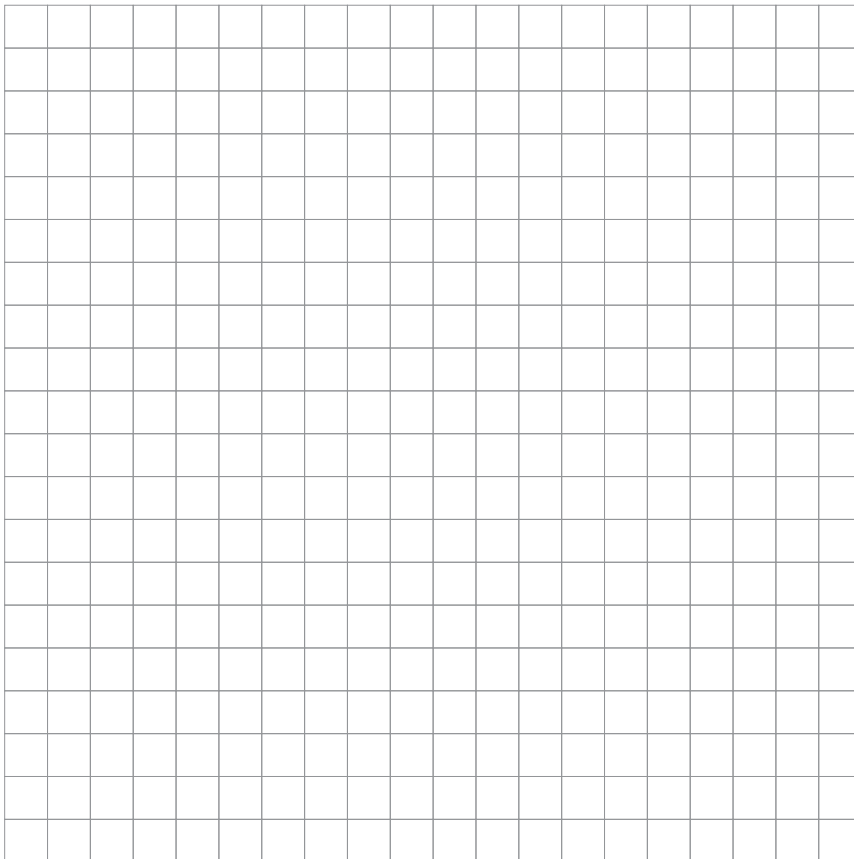

Company: \_\_\_\_\_

Dimensions of stand:

\_\_\_\_\_ m X \_\_\_\_\_ m



Please outline the stand on the grid and use the following symbols to indicate positions of the fittings required:

-  Wall panel
-  Door
-  Perspex panel
-  Flat shelf
-  Angled shelf
-  TV pad

Please add any further items ordered on the plan, clearly labelling each.

## Notes:

1. It's important that the sketch gives the orientation of the stand in relation to others.
2. Please ensure the information provided on this plan is accurate and up to date. Any items that need to be uninstalled and reinstalled onsite will incur additional charges.
3. Any problems must be reported to the onsite Nautilus Exhibitions staff as we cannot rectify problems once the event has gone live.
4. Please note, if the stand is to have uninterrupted graphic panels, this will affect which items can be installed on the stand. Please contact the Nautilus Exhibitions team to discuss the compatibility.



## Terms and Conditions:

1. Our quoted prices are based on the current costs of materials and labour. We reserve the right to pass on any increase in the same which occur prior to the completion of any work.
2. Orders and delivery dates are subject to us being able to secure the necessary materials. We accept no responsibility for non or part completion beyond our control.
3. If we are prevented from completing any work by any cause beyond our control, the customer shall pay us for the proportion of work carried out.
4. If a customer fails to settle the account after it has fallen due, we reserve the right to recover or suspend the delivery of further goods, or execution of further works.
5. All goods, materials and plan machinery supplied by us shall be on hire unless otherwise stated. The customer shall reimburse us for any loss or damage.
6. The period of hire will be that of the exhibition or otherwise stated. All items will be removed as soon as permitted by the exhibition organiser.
7. We do not exclude our liability in respect of death or personal injury resulting from negligence by ourselves (but not subcontractors, if any).
8. We do not exclude our liability for loss or damage to exhibitors or property of the customer where it has been caused by our negligence, provided that a claim is made within 14 days of the problem being brought to our attention.
9. Any claim resulting from no. 8 above shall be limited to the value of the goods, not in respect to any consequential costs incurred.
10. Any claims arising shall comply with the exhibition conditions.
11. The customer shall comply with all conditions imposed by the organisers or promoters.
12. We are not responsible for any loss, damage or injury resulting in delay or failure of delivery beyond our control, or failure or defect of any materials not manufactured by us.
13. We reserve the right to charge the customer for any additional costs incurred by works carried out in accordance with a request from health or safety organisation.
14. Unless otherwise agreed in writing, these terms and conditions apply to all contracts entered by us, to the exclusion of any terms and conditions in the customers' orders which conflict with ours.
15. All accounts are payable nett.

---

## PAYMENT POLICY

Nautilus Exhibitions requires payment in full at the time services are ordered.

Method of payment:

An invoice will be sent once the order has been received. Nautilus Exhibitions accepts all major credit/debit cards or bank transfers. Purchase orders are not considered payment.

**Full cleared payment must be received prior to the build-up of the show.**

Cancellations/Refunds - Please note that refunds will not be made on cancellation of any non-stock items. Any item ordered prior to and transported to the event is not eligible for a refund.

I agree in placing this order that I have accepted the Terms & Conditions of Nautilus.

Signed:

Print Name: \_\_\_\_\_ Date: \_\_\_\_\_

Please return the completed form to [info@nautilusexhibitions.co.uk](mailto:info@nautilusexhibitions.co.uk) with the email titled: [Company Name]\_UKGE\_ Completed Order Form

